

VICTRONIX

Add:	Room 1405A, Building 1B, Hua qiang Idea Park, GuangMing District, Shenzhen, China		
Tel:	+86-755-33265935	Fax:	+86-755-33265935

SPECIFICATION

VXO-119AMA-044

Preliminary Specification

Final Specification

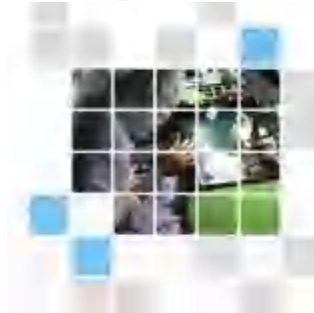

Customer:

Made By:

Checked By:

Approved By:

Quality:

Date:

Note:

Approved By:

Date:

Note:

CONTENTS

- **SCOPE**
- **FEATURES**
- **APPLICATION**
- **GENERAL INFORMATION**
- **ABSOLUTE MAXIMUM RATINGS**
- **ELECTRICAL CHARACTERISTICS**
- **OPTICAL CHARACTERISTICS**
- **INTERFACE DESCRIPTION**
- **EXTERNAL DIMENSIONS**
- **RELIABILITY TEST CONDITIONS**
- **INSPECTION CRITERION**
- **PRECAUTIONS FOR USING AMOLED MODULES**
- **PACKING SPECIFICATION**
- **PRIOR CONSULT MATTER**
- **FACTORY CONTACT INFORMATION**

■ SCOPE

This AMOLED module Specification defines general provisions and inspection standard, AMOLED modules Involved are supplied by Victronix Tecenstar INT'L Co., LTD. In the process of using, if unforeseen problem or unspecified items may occur, we have to negotiate to resolve the issue with the customer certainly.

■ FEATURES

- 1) Display color: 16.7M colors(24bits)
- 2) Display format: 1.2 Inch
- 3) Interface: MIPI 2lane/3-wire SPI/4-wire SPI/QAD-SPI
- 4) Driver IC: RM69330
- 5) Polarizer: Hard Coating Polarizer
- 6) ID: DA=0XA6,DB=0X30,DC=0X41

■ APPLICATION

Smart Watch

■ GENERAL INFORMATION

Item	Contents	Unit
Display Mode	AMOLED	/
LTPS Glass Outline (W×H)	33.22×33.75	mm
Encapsulation Glass Outline (W×H)	33.22×32.75	mm
Active area (W×H)	φ 30.42	mm
Number of Dots	390×3(RGB)×390	/
Diagonal Inch	1.2	inch
Pixel pitch (W×H)	78×78	um
Glass Thickness	0.2 (LTPS) 0.205(Encap) 0.678(Total)	mm

■ ABSOLUTE MAXIMUM RATINGS

Parameter	Symbol	Min	Max	Unit
Supply voltage (Display)	VCC	-0.3	5.5	V
	IOVCC	-0.3	5.5	V
	ELVDD	0.0	6.0	V
	ELVSS	-6.5	0.0	V
Operating temperature	T _{OP}	-20	70	oC
Storage temperature	T _{ST}	-30	80	oC
Humidity	RH	-	90	%RH

Note: Absolute maximum ratings means the product can withstand short-term, NOT more than 120 hours. If the product is a long time to withstand these conditions, the life time would be shorter.

■ ELECTRICAL CHARACTERISTICS

Parameter		Symbol	Condition	Min	Typ	Max	Unit
Supply voltage (Display)		VCC	-	2.7	3.3	3.6	V
		IOVCC	-	1.65	1.8	3.3	V
		ELVDD	-	4.55	4.6	4.65	V
		ELVSS	-	-2.25	-2.2	-2.15	V
Input voltage	'L' level	VIL	IOVCC=1.65V~3.3V	GND	-	0.2*IOVCC	V
	'H' level	VIH		0.8*IOVCC	-	IOVCC	V
Output voltage	'L' level	VOL	I(OH)=-1mA I(OL)=+1mA	GND	-	0.2*IOVCC	V
	'H' level	VOH		0.8*IOVCC	-	IOVCC	V
Current (Display)	Sleep out mode	I _{VCC}	Full white display	-	2	4	mA
		I _{IOVCC}		-	1.5	3	mA
		I _{ELVDD/ELVSS}		-	13	19.5	mA
	Sleep in mode	I _{VCC}	-	20	40	uA	
		I _{IOVCC}	-	50	100	uA	
	Deep Standby Mode	I _{VCC}	-	1	3	uA	
I _{IOVCC}		-	1	3	uA		
Frame Frequency	f _{FRM}		-	45	-	Hz	

■ OPTICAL CHARACTERISTICS

Item	Symbol	Condition	Min	Type	Max	Unit	Note
Surface Luminance	Lv	$\theta=0^\circ$ $\varnothing=0^\circ$ $T_a=25^\circ\text{C}$	300	350	400	cd/m ²	Note1
Luminance uniformity	δ WHITE		85	-	-	%	Note2
Contrast Ratio	Cr		60000	-	-	-	Note3
Viewing Angle	θ	Up/Down/Right/Left Cr \geq 200	88	-	-	deg	Note4
Color Coordinate of CIE 1931	Red x	$\theta=0^\circ$ $\varnothing=0^\circ$ $T_a=25^\circ\text{C}$	0.630	0.660	0.690	-	Note 5
	Red y		0.310	0.340	0.370	-	
	Green x		0.170	0.220	0.270	-	
	Green y		0.680	0.730	0.780	-	
	Blue x		0.115	0.140	0.165	-	
	Blue y		0.025	0.050	0.075	-	
	White x		0.275	0.295	0.315	-	
	White y		0.295	0.315	0.335	-	
NTSC ratio	-	-	90	110	-	%	CIE1931
Cross talk	-	25°C.	-	-	3	%	-
Flicker	-	25°C.	-	-	3	DB	-
Gamma	-	$\theta=0^\circ$ $\varnothing=0^\circ$ $T_a=25^\circ\text{C}$. V(Gray)=44,68,100,132,164,196,228,252,225	2.0	2.2	2.4	-	
Lifetime	T95	25°C.	240			h	

Note1. Surface Luminance

- Measurement equipment: CS2000 or similar equipment.
- Measuring surroundings: Dark room.
- Measuring temperature: $T_a=25^\circ\text{C}$.
- The data are measured after OLEDs are lighted on for more than 5 minutes and all pixels are fully white.
- The Surface Luminance is the average value of 5 measured spots (Fig-1):

$$L_v = \text{Average Luminance with all white pixels (P}_1, P_2, P_3, P_4, P_5)$$

Note2. Luminance Uniformity

- Measurement equipment: CS2000 or similar equipment.
- Measuring surroundings: Dark room.
- Measuring temperature: $T_a=25^\circ\text{C}$.
- The data are measured after OLEDs are lighted on for more than 5 minutes and all pixels are fully white.
- The Luminance Uniformity is calculated by using following formula:

$$\delta \text{ WHITE} = L_p (\text{Min.}) / L_p (\text{Max.}) \times 100 (\%)$$

$$L_p (\text{Min.}) = \text{Minimum Luminance with all white pixels (P}_1, P_2, P_3, P_4, P_5)$$

$$L_p (\text{Max.}) = \text{Maximum Luminance with all white pixels ((P}_1, P_2, P_3, P_4, P_5)$$

Note3. Contrast Ratio

- Measurement equipment: CS2000 or similar equipment.
- Measuring surroundings: Dark room.
- Measuring temperature: $T_a=25^{\circ}\text{C}$.
- The data are measured after OLEDs are lighted on for more than 5 minutes.
- The Contrast Ratio is calculated by using following formula:

$$\text{Contrast Ratio(Cr)} = L_w / L_b$$

L_w = Average Luminance with all **white** pixels (P_1, P_2, P_3, P_4, P_5)

L_b = Average Luminance with all **black** pixels (P_1, P_2, P_3, P_4, P_5)

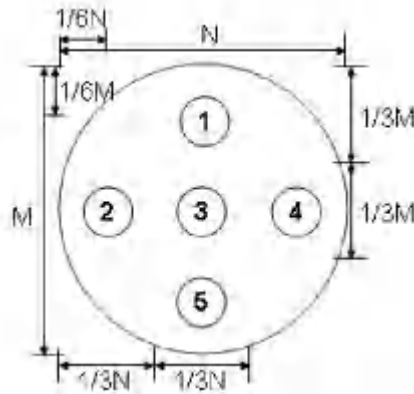

Fig-1

Note4. Viewing Angle

- Measurement equipment: DMS803 or similar equipment.
- Measuring surroundings: Dark room.
- Measuring temperature: $T_a=25^{\circ}\text{C}$.
- The Viewing Angle is the angle at which the contrast ratio is greater than 10. The angles are determined for the horizontal or x axis and the vertical or y axis with respect to the z axis which is normal to the display surface.

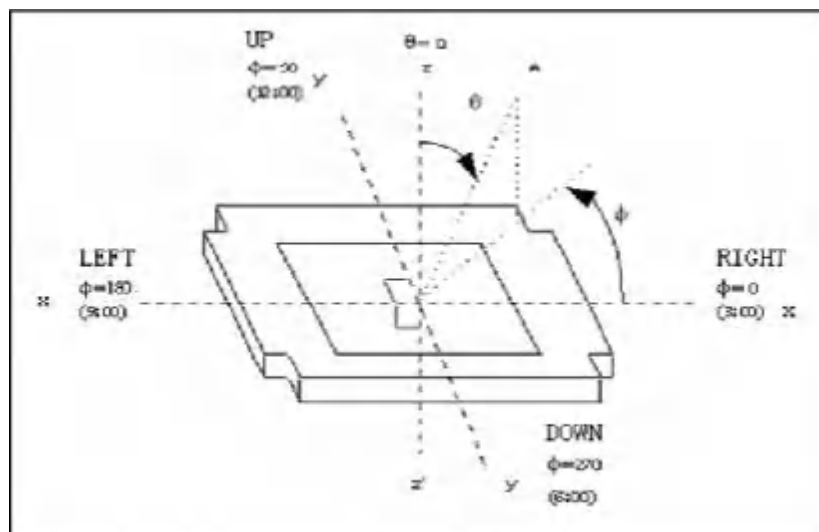

Fig-2

Note5. Color Coordinate of CIE1931

- Measurement equipment: CS2000 or similar equipment.
- Measuring surroundings: Dark room.
- Measuring temperature: $T_a=25^{\circ}\text{C}$.
- The x, y value of Color Coordinate is determined by measuring at center position of the display panel.

■ INTERFACE DESCRIPTION

Interface NO.	Symbol	I/O or Connected to	Description	When not in use
1	MTP_PWR	power	MTP programming power supply pin. (7.5V typical)	Left open or connected to GND
2	GND	Connected to GND	Ground.	/
3	D0P	I/O	MIPI interface	Connected to GND
4	D0N			
5	GND	Connected to GND	Ground	/
6	CLKP	I	MIPI inter face	Connect to GND
7	CLKN			
8	GND	Connected to GND	Ground	/
9	DIP	I	MIPI inter face	Connected to GND
10	DIN			
11	GND	Connected to GND	Ground	/
12	IM0	I	Inter face type selection. IM[1:0]=00:MPI/3-wire SPI; IM[I:0]=01:MIPI/4-wire SPI; IM[I:0]=10:MIPI/QAD- SPI; IM[I:0]=11:MCU 8-BIT,	/
13	IMI			
14	GND	Connected to GND	Ground.	/
15	D[7]	I/O	8-bit bi-directional data bus for 80-series MPU I/F	Open
16	D[6]			
17	D[5]			
18	D[4]			
19	D[3]			
20	D[2]			
21	D[1]			
22	D[0]			
23	GND	Connected to GND	Ground	/
24	CSX	I	Chip select input pin (“Low” enable) in SPI I/F	Connected to IOVCC
25	WRX_SCL	I	A synchronous clock signal in SPI I/F	Connected to GND
26	DCX	I	Display data/command selection in 4-wire SPI I/F. DCX=“0” : Command DCX=“1” : Display data or Parameter	Connected to GND
27	SDI_RDx	I/O	Serial output signals in SPI I/F. The data is input on the rising edge of the SCL signal.	Open
28	SDO	O	Serial output signals in SPI I/F. The	Open

			data is output on the rising/falling edge of the SCL signal. If the host places the SDI line into high-impedance state during the read interval, the SDI and SDO can be tied together.	
29	RESET	I	This signal will reset the device and must be applied to properly initialize the chip. Signal is active low.	/
30	TE	O	Tearing effect output pin to synchronize MCU to frame writing, activated by S/W command.	Open
31	OLED_EN	O	Power IC enable control pin (Note: "H"=IOVCC level, "L"= GND level.)	/
32	SWIRE	O	Swire protocol setting pin of Power IC.	/
33	GND	Connected to GND	Ground	/
34	VCC	Power	Power supply for Analog circuit.	/
35	IOVCC	Power	Power supply for interface system	/
36	GND	Connected to GND	Ground.	/
37	ELVDD	Power	Power supply for pixel circuit.	/
38	ELVDD			
39	ELVDD			
40	GND	Connected to GND	Ground.	/
41	ELVSS	Power	Power supply for pixel circuit.	/
42	ELVSS			
43	ELVSS			
44	GND	Connected to GND	Ground.	/
45	GND			

Module Block Diagram

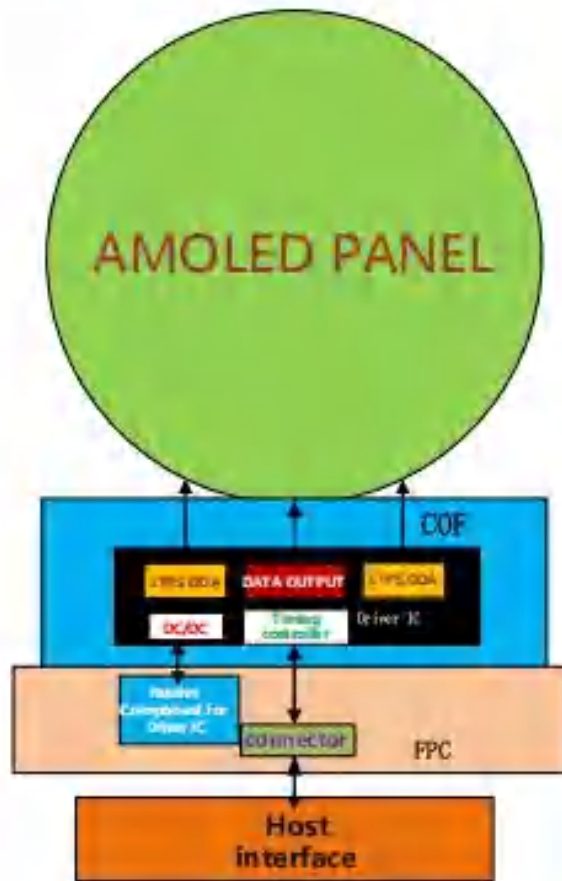
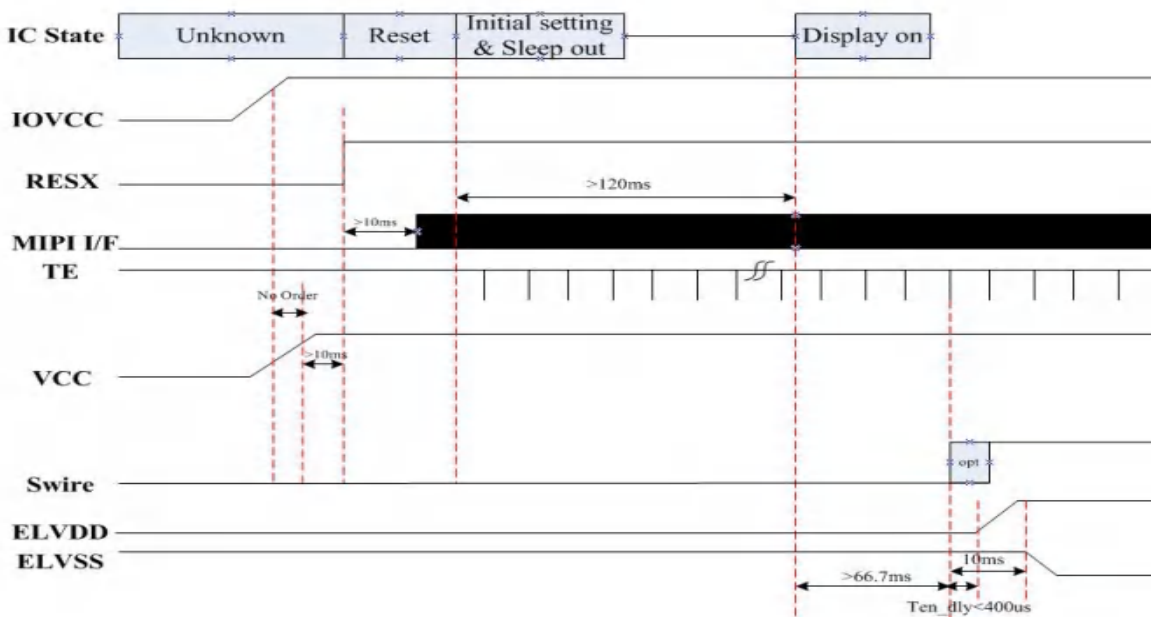

Fig-3

Recommended Operating Sequence

Power on sequence



Power off sequence

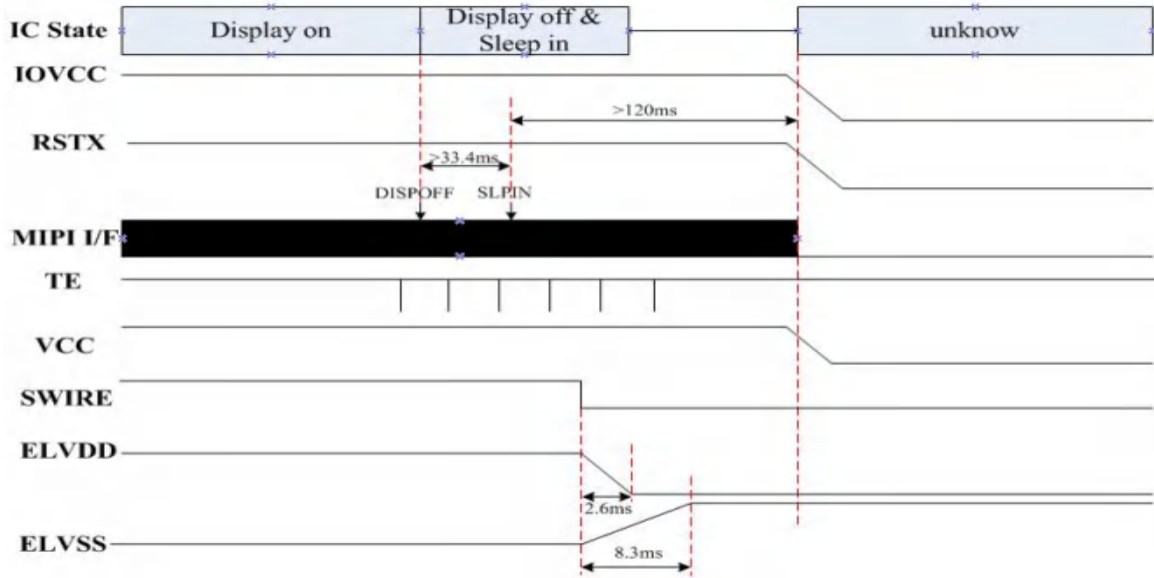

Reset Timing

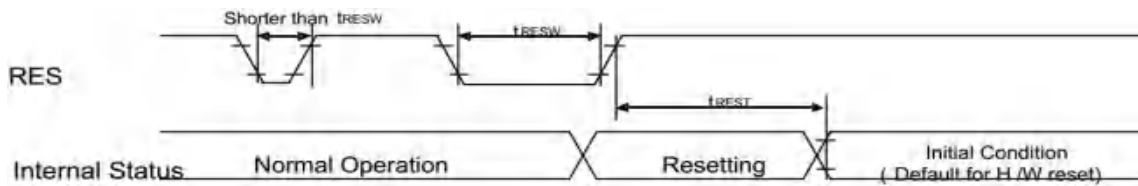

Reset input timing:

IOVCC=1.65 to 3.3V, VCC=2.7 to 3.6V, AGND=DGND=0V, Ta=-40 to 85°C

Symbol	Parameter	Related Pins	MIN	TYP	MAX	Note	Unit
tRESW	Reset low pulse width	RESX	10	-	-	-	Us
tREST	Reset complete time	-	-	-	5	When reset applied during Sleep in mode	ms
		-	-	-	120	When reset applied during Sleep out mode	ms

EXTERNAL DIMENSIONS

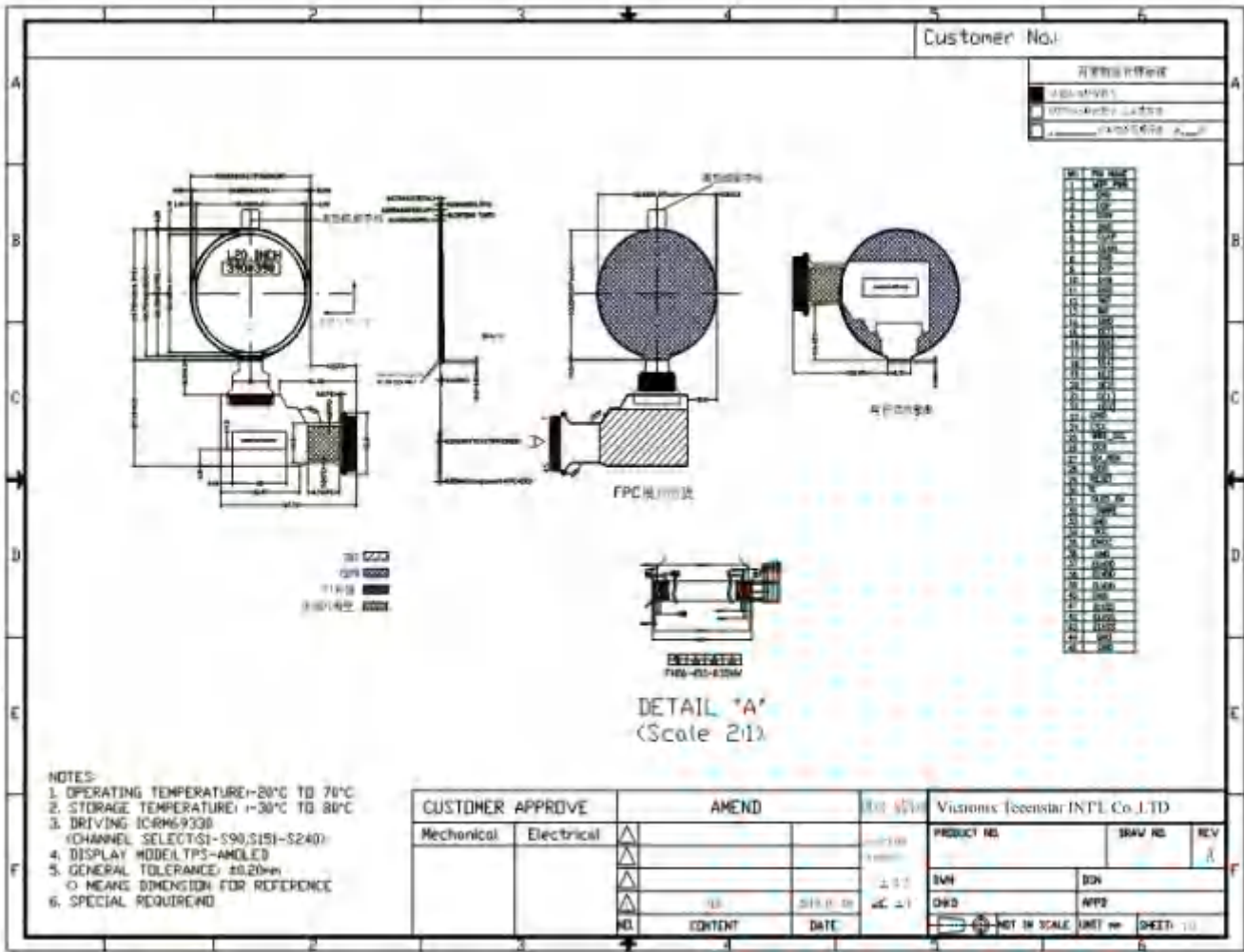

■ RELIABILITY TEST CONDITIONS

No.	Test Item	Test Condition	Qty	Inspection after test
1	High Temperature Storage	80°C±2°C/240 hours	5	Inspection after 2 hours storage at room temperature, the sample shall be free from defects: 1. Remarkable deterioration of No clearly visible defects or display quality. However, any polarizer's deteriorations by the high temperature/ High humidity Storage test and the High temperature/ High humidity Operation test are permitted. 2. No function-related abnormalities. 3. Optical criteria : .White $\Delta u'v' \leq 0.02$ 4. No visible defects .(optical / mechanical) .
2	Low Temperature Storage	-30°C±2°C/240 hours	5	
3	High Temperature Operating	70°C±2°C/240 hours	5	
4	Low Temperature Operating	-20°C±2°C/240 hours	5	
5	Temperature Cycle storage	-30°C±2°C~25~80°C±2°C×30cycles (30min.) (5min.) (30min.)	5	
6	High Temperature Humidity Storage	60°C±5°C×90%RH/240 hours	5	
7	ESD test	Voltage:±8KV R: 330Ω C: 150pF Air discharge, 10time	5	
8	Vibration Test	Frequency: 10Hz~55Hz~10Hz Amplitude: 1.5mm, X, Y, Z direction for total 3hours (Packing condition)	5	
9	Dropping test	Drop to the ground from 75cm height, one time, every side of carton. (Packing condition)	5	

Remark:

- 1.The test samples should be applied to only one test item.
- 2.For Damp Proof Test, Pure water(Resistance>10MΩ) should be used.
- 3.In case of malfunction defect caused by ESD damage, if it would be recovered to normal state after resetting, it would be judged as a good part.
- 4.Failure Judgment Criterion: Basic Specification, Electrical Characteristic, Mechanical Characteristic, Optical Characteristic.

■INSPECTION CRITERION

OUTGOING QUALITY STANDARD	Edition: A
TITLE:FUNCTIONAL TEST & INSPECTION CRITERIA	AMOLED Product

This specification is made to be used as the standard acceptance/rejection criteria for AMOLED Product

1.1 Sample plan

Sampling plan according to GB/T2828.1-2003/ISO 2859-1: 1999 and ANSI/ASQC Z1.4-1993, normal level 2 and based on:

Major defect: AQL 0.65

Minor defect: AQL 1.5

1.2 Inspection condition

Visual: Viewing distance for cosmetic inspection is about 30cm with bare eyes, and under an environment of 30~40W light intensity(1000±200LUX) or function inspection (illumination intensity≤50LUX), all directions for inspecting the sample should be within 45° against perpendicular line. Cosmetic inspection time is 10s, judged pass if the defect cannot be seen in 15s.

Inspection pattern: Red/Green/Blue/White/Black/128 gray scale

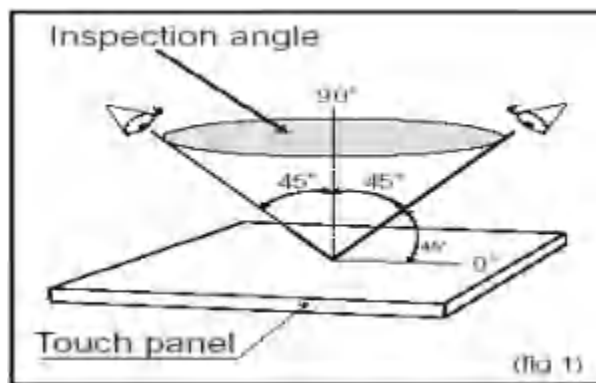

1.3 Definition of AMOLED inspection zone

Zone A: Character/Digit area

Zone B: Viewing area except Zone A (Zone A + Zone B=minimum Viewing area)

Zone C: Outside viewing area (invisible area after assembly in customer's product)

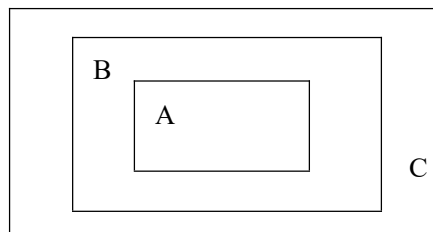

1.4 Inspection standards

1.4.1 Definition of the defect size:

Spot shape:

Line shape:

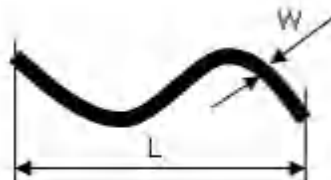
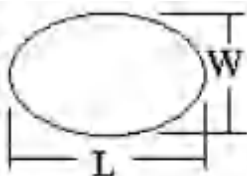

$$D = (L+W) / 2$$



D: Diameter L: Length W: Width N: Number DS: Distance

1.4.2 Major defect

Item No.	Inspection Item	Inspection standards
(1)	Function defects	1) No display not allowed 2) Display abnormally not allowed 3) Bright/Dark line and other line-shape function defect not allowed
(2)	Component	Missing/breakage component not allowed
(3)	Outline dimension	Overall outline dimension beyond the drawing is not allowed
(4)	Sharp edge	Not allowed
(5)	FPC	Split/Breakage FPC not allowed

1.4.3 Minor defect

Item No.	Inspection Item	Inspection standards					
(1)	Spot defect: Black and white Spot, Foreign Particle, Dirt under polarizer (Except dark pixel)	Grade A			Grade B		
		Size (mm)	Acceptable Qty.		Size (mm)	Acceptable Qty.	
		$D \leq 0.10, DS \geq 10$	Disregard		$D \leq 0.10, DS \geq 10$	Disregard	
		$0.10 < D \leq 0.2, DS \geq 10$	$N \leq 2$		$0.10 < D \leq 0.25, DS \geq 10$	$N \leq 3$	
		$D > 0.2$	$N = 0$		$D > 0.25$	$N = 0$	
(2)	Bright spot (pixel)	$N \leq 0$			$N \leq 0$		
(3)	Dark spot (pixel)	$N \leq 4, DS \geq 10$			$N \leq 8, DS \geq 10$		
(4)	Line defect Black line, White line, Foreign material	Grade A			Grade B		
		L (Length)	W (Width)	Acceptable Qty.	L (Length)	W (Width)	Acceptable Qty.
			$W \leq 0.02$	Disregard		$W \leq 0.02$	Disregard

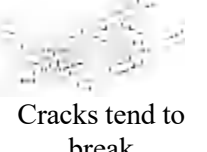
	under polarizer	$L \leq 2.0$	$0.02 < W \leq 0.03$	$N \leq 2$	$L \leq 2.0$	$0.02 < W \leq 0.03$	$N \leq 3$
		$L \leq 1.0$	$0.03 < W \leq 0.05$	$N \leq 2$	$L \leq 1.0$	$0.03 < W \leq 0.05$	$N \leq 3$
			$W > 0.05$	$N = 0$		$W > 0.05$	$N = 0$
(5)	Mura	Judged OK if unviewable by using 3% ND Filter on 128 gray scale pattern. Special requirement refer to the limit sample signed by customer			Not affect assembly use. Special requirement refer to the limit sample signed by customer		
(6)	Color mixing	Judged OK if unviewable by using 2% ND Filter on White (255 gray scale) pattern. Special requirement refer to the limit sample signed by customer			Not affect assembly use. Special requirement refer to the limit sample signed by customer		
(7)	Bubble	Size (mm)	Acceptable Qty.		Size (mm)	Acceptable Qty.	
		$D \leq 0.2$	Disregard		$D \leq 0.2$	Disregard	
		$0.2 < D \leq 0.5$	$N \leq 2$		$0.2 < D \leq 0.5$	$N \leq 3$	
		$D > 0.5$	$N = 0$		$D > 0.5$	$N = 0$	
(8)	Fingerprint	Not allowed					
(9)	 Usual surface cracks	$z \leq t$: $Y \leq 0.5\text{mm}$, $X \leq 2\text{mm}$ z : Crack thickness; t : Glass thickness			$z \leq t$: $Y \leq 1\text{mm}$, $X \leq 3\text{mm}$ z : Crack thickness; t : Glass thickness		
(10)	 Chips on corner	$z \leq t$: $Y \leq 2\text{mm}$, $X \leq 2\text{mm}$ z : Chips thickness; t : Glass thickness			$z \leq t$: $Y \leq 3\text{mm}$, $X \leq 3\text{mm}$ z : Chips thickness; t : Glass thickness		
(11)	 Cracks tend to break	Cracks tend to break are not allowed. Edge burrs disregard.					

Notes: Base on Victronix Tecenstar IN'L Co.,LTD standard if the defects not be mentioned above, all the standards ultimately oriented to the terminal customer and satisfy customer,s request.

■ PRECAUTIONS FOR USING AMOLED MODULES**Handling Precautions**

- 1 The display panel is made of glass and polarizer. As glass is fragile. It tends to become or chipped during handling especially on the edges. Please avoid dropping or jarring. Do not subject it to a mechanical shock by dropping it or impact.
- 2 Do not apply excessive force to the display surface or the adjoining areas since this may cause the color tone to vary. Do not touch the display with bare hands. This will stain the display area and degraded insulation between terminals (some cosmetics are determined to the polarizer).
- 3 The polarizer covering the display surface is soft and easily scratched. Handle this polarizer carefully. Do not touch, push or rub the exposed polarizers with anything harder than an HB pencil lead (glass, tweezers, etc.). Do not put or attach anything on the display area to avoid leaving marks on it. Condensation on the surface and contact with terminals due to cold will damage, stain or dirty the polarizer. After products are tested at low temperature they must be warmed up in a container before coming in to contact with room temperature air.
- 4 If the display surface becomes contaminated, breathe on the surface and gently wipe it with a soft dry cloth. If it is heavily contaminated, moisten cloth with one of the following solvents
 - Isopropyl alcohol
 - Ethyl alcoholDo not scrub hard to avoid damaging the display surface.
- 5 Solvents other than those above-mentioned may damage the polarizer. Especially, do not use the following.
 - Water
 - Ketone
 - Aromatic solventsWipe off saliva or water drops immediately, contact with water over a long period of time may cause deformation or color fading. Avoid contact with oil and fats.
- 6 Exercise care to minimize corrosion of the electrode. Corrosion of the electrodes is accelerated by water droplets, moisture condensation or a current flow in a high-humidity environment.
- 7 Do not attempt to disassemble or process the AMOLED module.
- 8 NC terminal should be open. Do not connect anything.
- 9 If the logic circuit power is off, do not apply the input signals.
- 10 Electro-Static Discharge Control , Since this module uses a CMOS LSI, the same careful attention should be paid to electrostatic discharge as for an ordinary CMOS IC. To prevent destruction of the elements by static electricity, be careful to maintain an optimum work environment.
 - Before removing AMOLED from its packing case or incorporating it into a set, be sure the module and your body have the same electric potential. Be sure to ground the body when handling the AMOLED modules.
 - Tools required for assembling, such as soldering irons, must be properly grounded. Make certain the AC power source for the soldering iron does not leak. When using an electric screwdriver to attach AMOLED modules, the screwdriver should be of ground potentiality to minimize as much as possible any transmission of electromagnetic waves produced sparks coming from the commutator of the motor.
 - To reduce the amount of static electricity generated, do not conduct assembling and other work under dry conditions. To reduce the generation of static electricity be careful that the air in the work is not too dry. A relative humidity of 50%-60% is recommended. As far as possible make the electric potential of your work clothes and that of the work bench the ground potential.
 - The AMOLED module is coated with a film to protect the display surface. Exercise care when peeling off this protective film since static electricity may be generated.
- 11 Since AMOLED has been assembled and adjusted with a high degree of precision, avoid applying excessive shocks to the module or making any alterations or modifications to it.
 - Do not alter, modify or change the shape of the tab on the metal frame.
 - Do not make extra holes on the printed circuit board, modify its shape or change the positions of components to be

attached.

- Do not damage or modify the pattern writing on the printed circuit board.
- Absolutely do not modify the zebra rubber strip (conductive rubber) or heat seal connector.
- Except for soldering the interface, do not make any alterations or modifications with a soldering iron.
- Do not drop, bend or twist the AMOLED.

Handling precaution for AMOLED

- 1 AMOLED is easy to be damaged. Please note below and be careful for handling.
- 2 Correct handling:
- 3 Incorrect handling:

Storage Precautions

- 1 When storing the AMOLED modules, the following precaution are necessary.
 - 1) Store them in a sealed polyethylene bag. If properly sealed, there is no need for the desiccant.
 - 2) Store them in a dark place. Do not expose to sunlight or fluorescent light, keep the temperature between 0. C and 35. C, and keep the relative humidity between 40%RH and 60%RH.
 - 3) The polarizer surface should not come in contact with any other objects (We advise you to store them in the anti-static electricity container in which they were shipped).
- 2 Transportation Precautions
 - 1) During shipment, please handle with care. The packaging bag can not be broken, step on trap. Packaging Carton layer height can not be over two meters.
 - 2) The transportation process should pay attention to the waterproof and moisture-proof measures. Product can not be watering. Ethylene sealed bags can not be unsealed.
- 3 Others
 - 1) To minimize the performance degradation of the AMOLED modules resulting from destruction caused by static electricity etc., exercise care to avoid holding the following sections when handling the modules.
 - a) - Exposed area of the printed circuit board.
 - b) -Terminal electrode sections.

USING AMOLED MODULES

1 Installing AMOLED Modules

The hole in the printed circuit board is used to fix AMOLED as shown in the picture below. Attend to the following items when installing the AMOLED.

- 1) Cover the surface with a transparent protective plate to protect the polarizer.
- 2) When assembling the AMOLED into other equipment, the spacer to the bit between the AMOLED and the fitting plate should have enough height to avoid causing stress to the module surface, refer to the individual specifications for measurements. The measurement tolerance should be ± 0.1 mm.

2 Precaution for assemble the module with BTB connector:

Please note the position of the male and female connector position, don't assemble or assemble like the method which the following picture shows

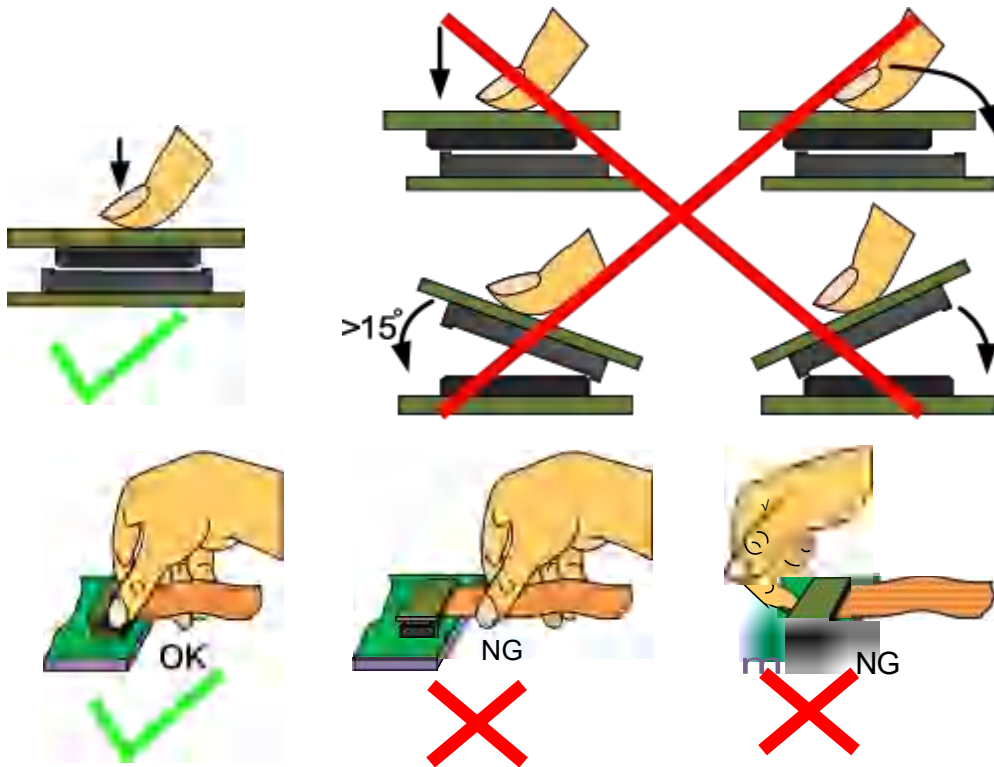

3 Precaution for soldering the AMOLED

	Manual soldering	Machine drag soldering	Machine press soldering
No RoHS Product	290. C~350. C. Time : 3-5S.	330. C~350. C. Speed : 4-8 mm/s.	300. C~330. C. Time : 3-6S. Press: 0.8~1.2Mpa
RoHS Product	340. C~370. C. Time : 3-5S.	350. C~370. C. Time : 4-8 mm/s.	330. C~360. C. Time : 3-6S. Press: 0.8~1.2Mpa

- 1) If soldering flux is used, be sure to remove any remaining flux after finishing to soldering operation (This does not apply in the case of a non-halogen type of flux). It is recommended that you protect the AMOLED surface with a cover during soldering to prevent any damage due to flux splatters.
- 2) When soldering the PC board, the board should not be detached more than three times. This maximum number is determined by the temperature and time conditions mentioned above, though there may be some variance depending on the temperature of the soldering iron.

4 Precautions for Operation

- 1) If the display area is pushed hard during operation, the display will become abnormal. However, it will return to normal if it is turned off and then back on.
- 2) A slight dew depositing on terminals is a cause for electro-chemical reaction resulting in terminal open circuit. Usage under the maximum operating temperature, 50%RH or less is required.
- 3) Input logic voltage before apply analog high voltage such as AMOLED driving voltage when power on. Remove analog high voltage before logic voltage when power off the module. Input each signal after the positive/negative voltage becomes stable.
- 4) Please keep the temperature within the specified range for use and storage. Polarization degradation, bubble generation or polarizer peel-off may occur with high temperature and high humidity.

5 Safety

- 1) It is recommended to crush damaged or unnecessary AMOLEDs into pieces and wash them off with solvents such as acetone and ethanol, which should later be burned.

6 Limited Warranty

Unless agreed between Victronix and the customer, Victronix will replace or repair any of its AMOLED modules

which are found to be functionally defective when inspected in accordance with Victronix AMOLED acceptance standards (copies available upon request) for a period of one year from date of production. Cosmetic/visual defects must be returned to Victronix within 90 days of shipment. Confirmation of such date shall be based on data code on product. The warranty liability of Victronix is limited to repair and/or replace on the terms set forth above. Victronix will not be responsible for any subsequent or consequential events.

7 Return AMOLED under warranty

- 1) No warranty can be granted if the precautions stated above have been disregarded. The typical examples of violations are :
 - a) - Broken AMOLED glass.
 - b) - PCB eyelet is damaged or modified.
 - c) - PCB conductors damaged.
 - d) - Circuit modified in any way, including addition of components.
 - e) - PCB tampered with by grinding, engraving or painting varnish.
 - f) - Soldering to or modifying the bezel in any manner.
- 2) Module repairs will be invoiced to the customer upon mutual agreement. Modules must be returned with sufficient description of the failures or defects. Any connectors or cable installed by the customer must be removed completely without damaging the PCB eyelet, conductors and terminals.

■ PACKING SPECIFICATION

Please consult our technical department for detail information.

■ PRIOR CONSULT MATTER

- 1 For standard products, we keep the right to change material, process ... for improving the product property without prior notice to our customer.
- 2 If you have special requirement about reliability condition, please let us know before you start the test on our samples.